

| | |
|----------------------------------|----|
| Durability Champion | 2 |
| Encapsulated Wood Core | 10 |
| SMART LINE - The smart choice | 14 |
| WOOD CLASSIC | 16 |
| XL WOOD | 22 |
| XL STONE | 28 |
| Facts | 34 |

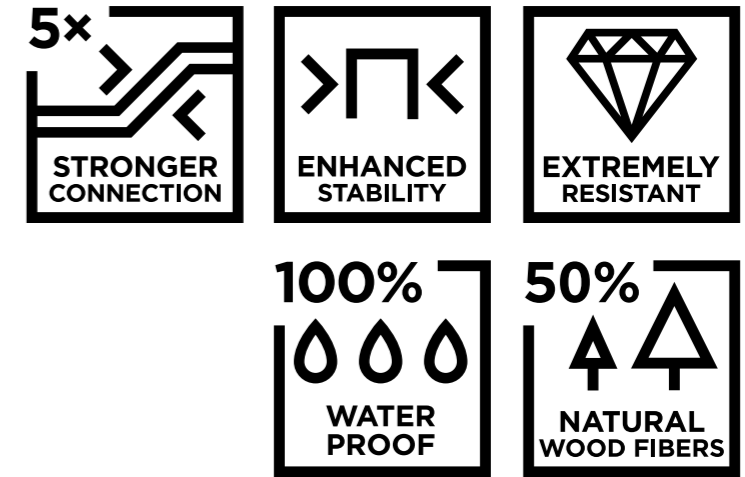

DURABILITY CHAMPION

We all lead full, busy lives. That's why we need resilient flooring that can keep up with our active lifestyles. Corepel can.



■ Five times stronger than other resilient flooring, Corepel is the most durable around. It is extremely stable and resistant to scratches and dents.

Made with an encapsulated wood core, Corepel floors are proven fully waterproof and extremely resistant. That means these floors stand up to whatever life throws at them: young children, pets, broken bottles of wine. Through it all,

Corepel remains just as beautiful and functional as ever.

Made of over 50% wood, Corepel has the highest share of renewable raw materials in the category. It's the first floor to qualify for the new Durable Eco Composite (DEC) standard.

Corepel: In it for the long haul.

5X STRONGER

Let the sun shine in!
With Corepel, you don't need to worry about the impact the sun's rays will have on your floor.

■ Featuring a rigid wood core encapsulated in thermo-setting resin, Corepel has best-in-class dimensional stability. Its interlocking panels fit together like the pieces of a jigsaw puzzle. And this tight connection remains strong even when exposed to temperature changes. Their locking force is 5x stronger than other resilient floors.

That extraordinary tensile strength is measured at the joints. Often the weakest link in a floor, where swelling or breakage occurs, the joints in Corepel remain tight even under the most demanding conditions. It makes for a beautiful, stable floor - one which holds up over time. The encapsulated wood core prevents damage due to shrinkage or expansion. There's no need for transition moldings when moving between rooms. Its rigid core is even more forgiving, lying flat even atop uneven subfloors.

So go ahead, open the curtains, even with floor to ceiling windows. Let the warmth in. Corepel stays flat, and won't expand or warp, even when things heat up inside.

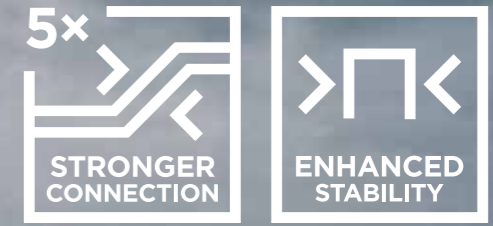

Tensile strength test:
5x stronger locking force

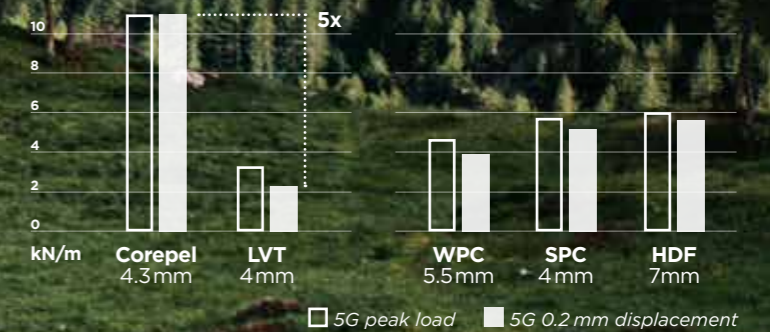

A proven advantage (ISO 24334:2019) - Corepel's exceptional strength has been confirmed using tensile strength tests. When two locked panels are pulled apart, Corepel panels withstand a force that is up to 5x higher than panels with LVT, WPC, SPC and HDF core.

FULLY WATERPROOF

A tight fit for your peace of mind. 100% waterproof Corepel.

Edge Swelling test

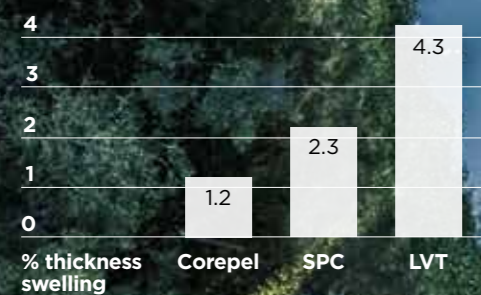

Proven waterproof: The Edge Swelling test (ISO 24336:2005) reveals what happens to floors when soaked in water. Corepel makes a real difference: While other floors with waterproof claims do actually swell, Corepel remains the best choice in these tough environments.



Water and wood go together like fire and ice. Puddles and spilled liquids can create warping and mold on wood flooring that have no place in your home. With Corepel floors, you can keep your peace of mind.

100% waterproof, you can even use Corepel in bathrooms, laundry nooks, mud rooms. Corepel panels will not swell, crack, warp or peel when exposed to water. Very tight joints prevent liquid from leaking through. Easy to maintain, you can use wet mops on spills or steam clean without a second thought. Corepel is ideal for young families or pets.

So you don't need to worry about puddles from melting snow. You can keep your dog inside. With waterproof Corepel, you can still retain that peaceful state of mind.

EXTREMELY RESISTANT

Corepel holds up to your active lifestyle.

■ Soccer cleats. Surfboards. Climbing gear. With their sharp edges and heavy weight, your sports equipment can do some serious damage to the floor. Not with Corepel floors.

Corepel holds up to your active lifestyle. A pet's claws or dropped vase are no match for its very high scratch resistance. With commercial grade wear resistance, Corepel maintains its original surface appearance. Dents are a thing of the past. And with high impact resistance, you can

breathe easy as life goes on. Corepel holds up under even the most extreme indoor conditions.

Ideal for use in high traffic areas, go ahead and lay Corepel in your mudroom or entryway. It'll maintain its functionality. It even stands up when exposed to both extreme heat and cold, making it a great addition to your kitchen or perfect flooring for your sun room. Corepel remains functional in even the most demanding conditions.

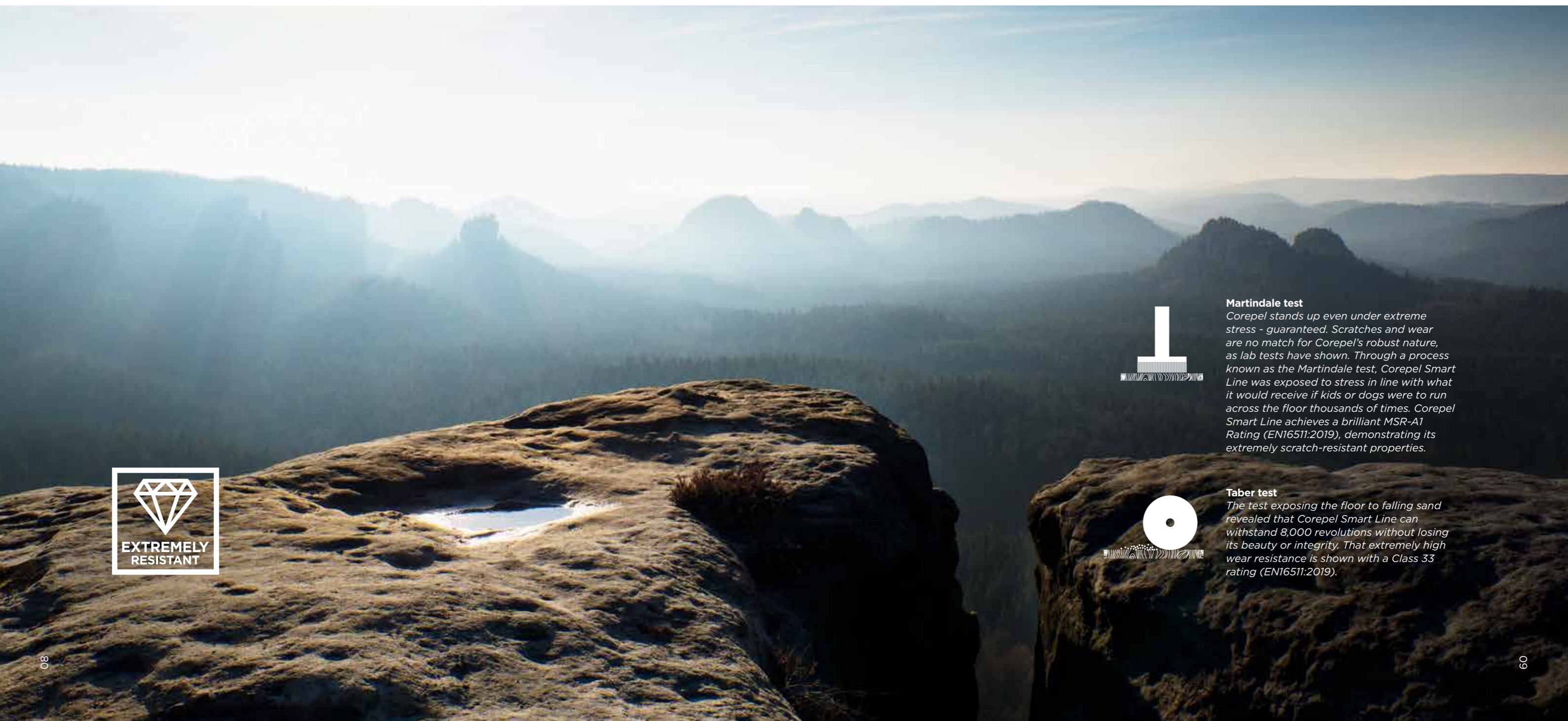

Martindale test

Corepel stands up even under extreme stress - guaranteed. Scratches and wear are no match for Corepel's robust nature, as lab tests have shown. Through a process known as the Martindale test, Corepel Smart Line was exposed to stress in line with what it would receive if kids or dogs were to run across the floor thousands of times. Corepel Smart Line achieves a brilliant MSR-A1 Rating (EN16511:2019), demonstrating its extremely scratch-resistant properties.



Taber test

The test exposing the floor to falling sand revealed that Corepel Smart Line can withstand 8,000 revolutions without losing its beauty or integrity. That extremely high wear resistance is shown with a Class 33 rating (EN16511:2019).

ENCAPSULATED WOOD CORE

Nature protects its treasures.
Like an oyster shell protects the
pearl inside, Corepel treasures its
natural wood fibers, encapsulating
them in high-performance resin.



■ Beauty comes from within. So does strength.

You can see that in Corepel, where the difference lies in the core. Just as an oyster uses its hard shell to protect its pearl from outside predators, Corepel treasures these natural wood fibers. The beauty and functionality of the wooden core is preserved thanks to high-performance resin. By encapsulating them in high-performance resin, Corepel becomes fully waterproof.

Made of more than 50% natural wood fibers, the Corepel core contains the highest share of renewable raw materials in a waterproof resilient floor. That's

twice as many as others on the market. These natural wood fibers are sourced from responsibly-managed, FSC-certified sources.

And the wooden core gives Corepel the strength to withstand whatever gets thrown its way. From falling vases to home workouts to high traffic, Corepel holds up to challenges over time. A strong core makes for a resilient floor.

Corepel is the first floor to qualify for the new Durable Eco Composite (DEC) standard. Corepel ranks lowest-in-class for emissions, making for excellent indoor air quality – as confirmed by the FloorScore, Greenguard Gold, VOC A+ and CARB2 certifications.

DURABLE ECO COMPOSITE - THE NEW STANDARD



With its unique material composition and durability performance, Corepel is the first floor to achieve the new Durable Eco Composite (DEC) standard.

| | | | | | |
|---------------------------------------|---------------------------------|------------|------------|------------|------------|
| Contains 30-70% wood fibers | ✓ | ✗ | ✗ | ✗ | ✓* |
| Composite with thermosetting resin | ✓ | ✗ | ✗ | ✗ | ✗ |
| Permitted for structural applications | ✓ | ✗ | ✗ | ✗ | ✓ |
| Fully waterproof | ✓ | ✓ | ✓ | ✓ | ✗ |
| Protected against fungi and insects | ✓ | ✓ | ✓ | ✓ | ✗ |
| Produced in continuous dry process | ✓ | ✗ | ✗ | ✗ | ✓ |
| | Corepel with DEC core | LVT | WPC | SPC | HDF |

*contains 70-100% wood fibers

SMART LINE THE SMART CHOICE

Who says you can't be soft and strong at the same time? Corepel Smart Line floors certainly are.

■ Coated with a SOFT SHIELD film, Smart Line features a very soft feel in a highly durable floor. The film makes for a smooth touch underfoot and an attractive matte finish.

Authentic in both materials and appearance, Smart Line closely emulates the natural elements. Those natural good looks hold up over time - no matter the wear and tear. Wood-fiber based, the floors are protected against fungi and moisture. With the ability to ward off abrasion, Smart Line achieved class 33 rating after testing. And though they look slick, the floor has proven slip resistant qualities, with class R10 rating. A lifetime residential ensures Corepel remains your floor for life (15 year commercial warranty).

Perfect for use in multi-family residences or open-plan rooms with high ceilings, Smart Line is quiet as a mouse. Equipped with an Eco Sound Hydro underlay, it is optimized to keep noise to a minimum. Its impact sound reduction reaches up to 21 decibels. A 5G click system makes for easy and fast installation.

| | |
|---|---|
|  | <p>XL WOOD 1845 x 244 x 7.5 mm 72.63" x 9.6" x 7.5 mm</p> <p>XL STONE 1380 x 396 x 7.5 mm 54.33" x 15.59" x 7.5 mm</p> <p>WOOD CLASSIC 1380 x 195 x 5.5 mm 54.33" x 7.67" x 7.5 mm</p> |
|---|---|

Corepel Smart Line floors are available in 3 formats.

Corepel Smart Line floors:

1. SOFT SHIELD film
2. True to life texture layer
3. Decorative layer
4. DEC rigid core
5. Tight and easy locking 5G click
6. Dimensional strengthening layer
7. Eco Sound Hydro acoustic underlay

SOFT SHIELD film

- » Hard-wearing
- » Antibacterial
- » Slip resistant
- » Extremely scratch and stain resistant

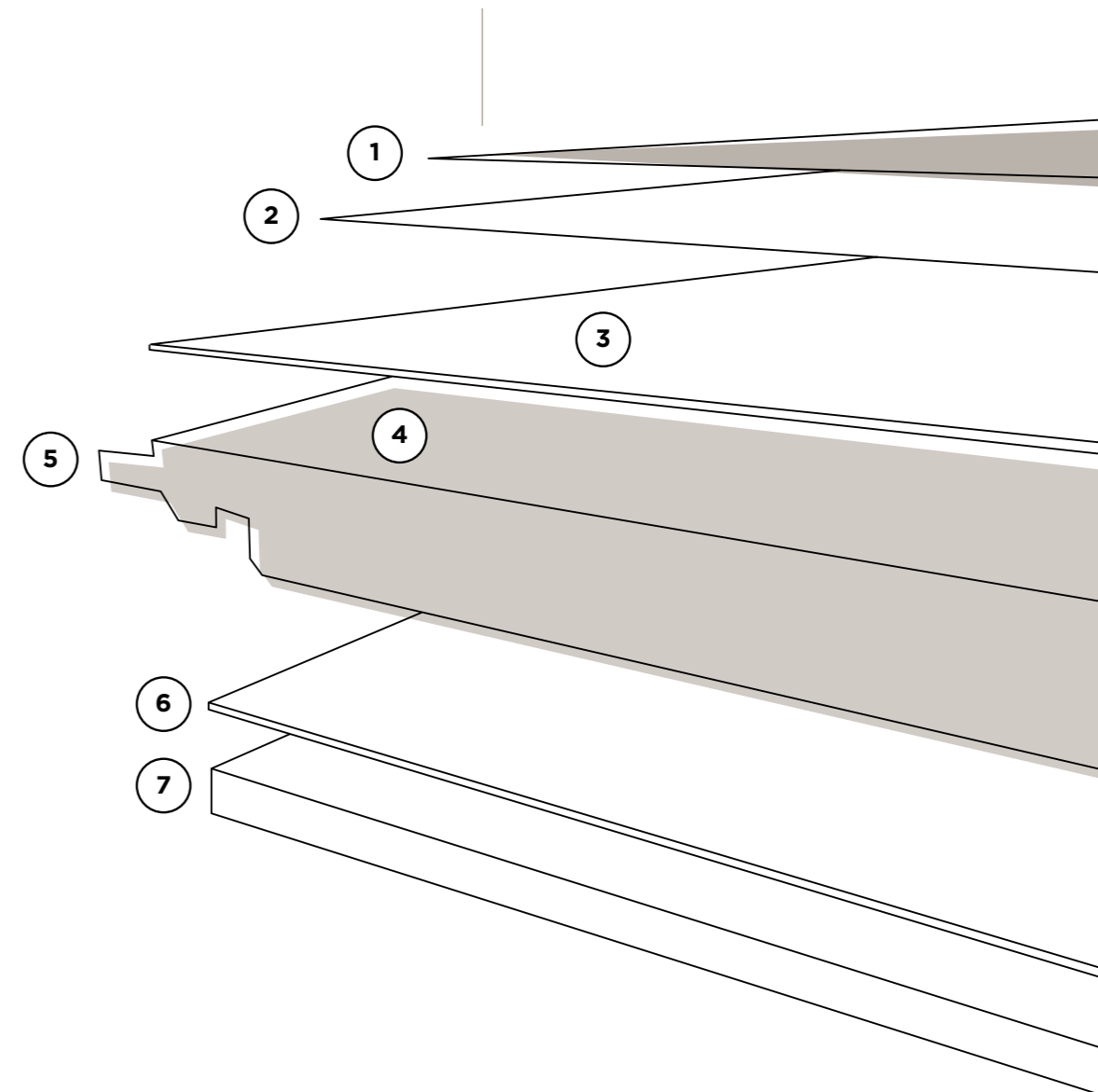

WOOD CLASSIC



4535 Albit Oak dark beige

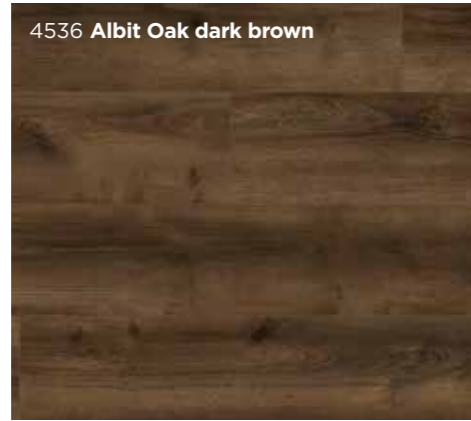

4536 Albit Oak dark brown

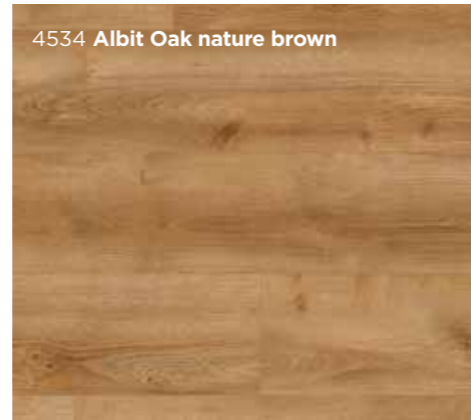

4534 Albit Oak nature brown

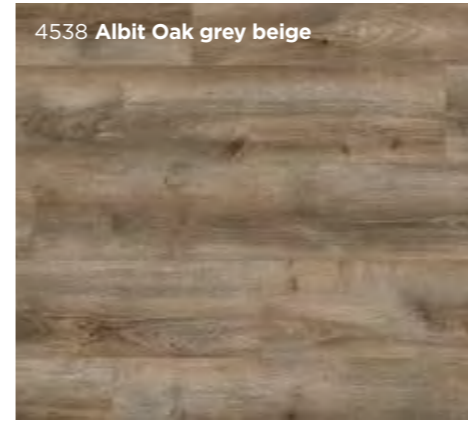

4538 Albit Oak grey beige

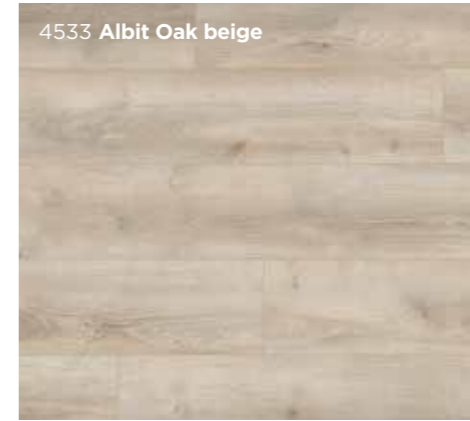

4533 Albit Oak beige

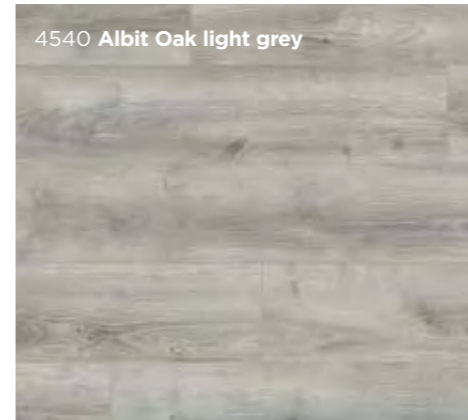

4540 Albit Oak light grey

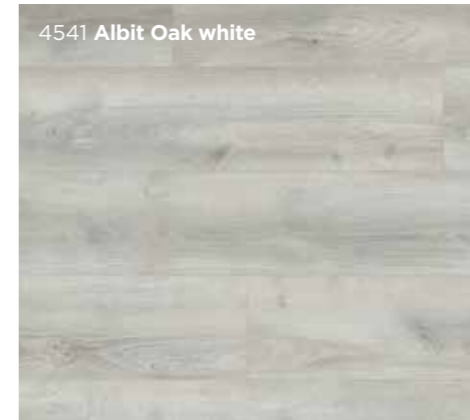

4541 Albit Oak white

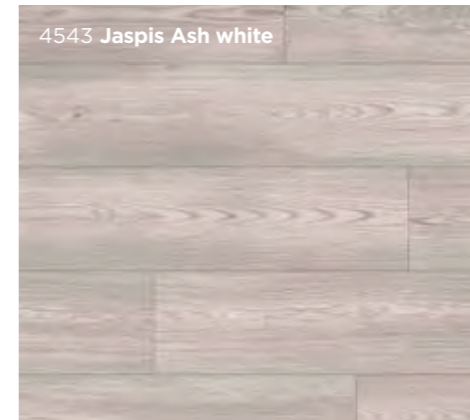

4543 Jaspis Ash white

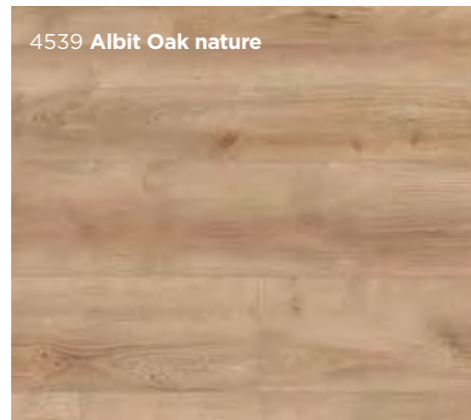

4539 Albit Oak nature

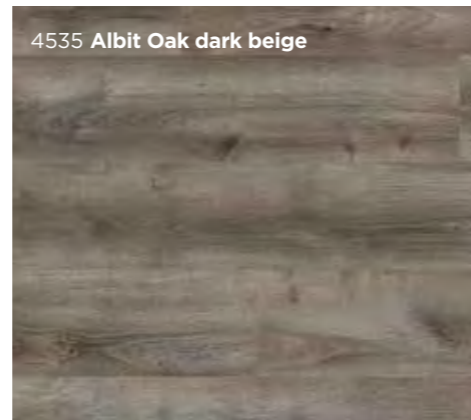

4535 Albit Oak dark beige

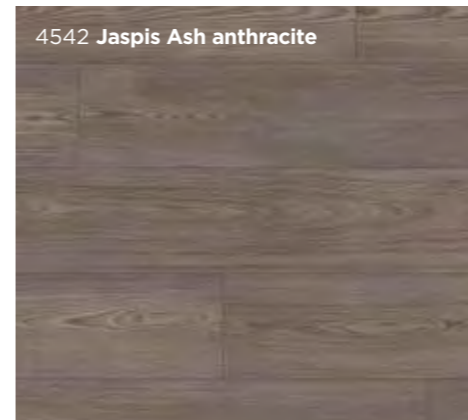

4542 Jaspis Ash anthracite

ELEGANT YET UNDER- STATED.

■ Scandinavian style. Wood Classic is sleek and unpretentious. Modern yet minimal. The natural, neutral aesthetic lays the groundwork for tasteful interiors.

▭ 1380 x 195 x 5.5 mm
54.33" x 7.67" x 7.5 mm



SMART LINE

WOOD CLASSIC

Room inspiration

4535 Albit Oak dark beige



■ The authentic wood look provides a neutral foundation that really pulls the room together. A darker wood stain paired with turquoise or watery blues and pastels creates a contemporary aesthetic that really pops. Subtle in appear-

ance, Wood Classic is complemented by pale or lightly patterned porcelain accents. Or combine a bleached oak floor in a sleek gray kitchen to create a mid-century modern update.

SMART LINE

WOOD CLASSIC

Room inspiration

XL WOOD



4550 Crystal Oak blond grey

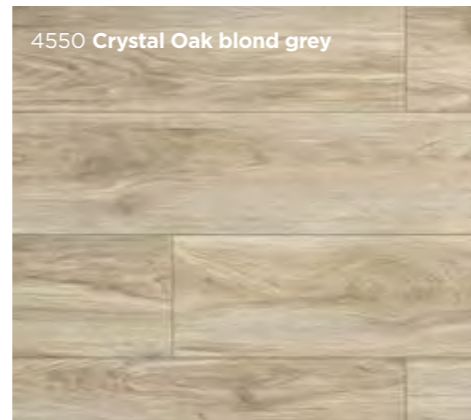
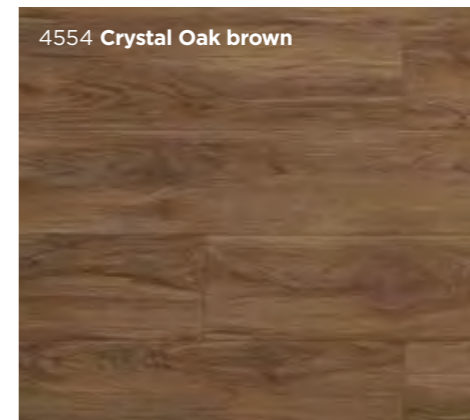
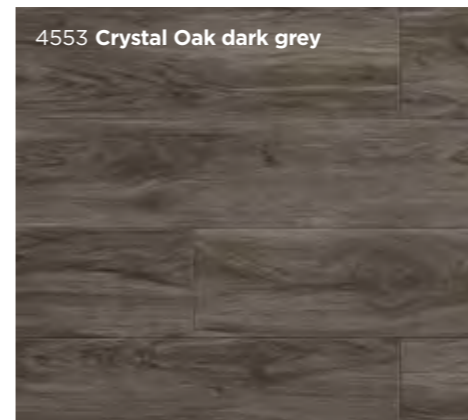
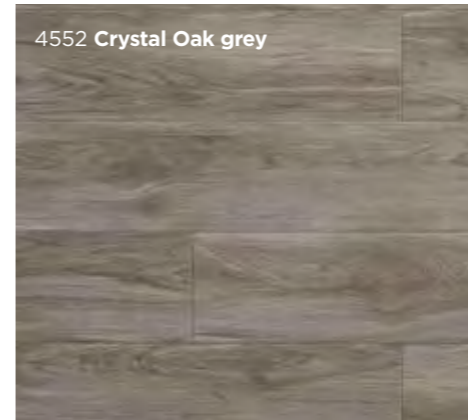
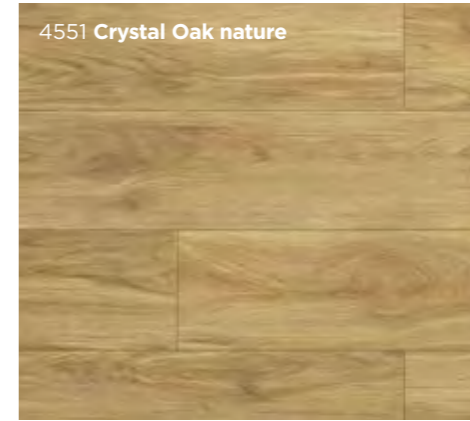
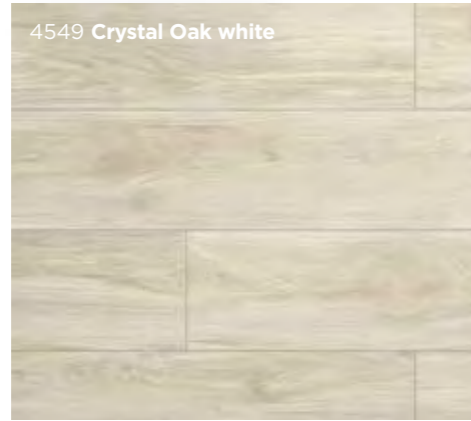

AN IDEAL AESTHETIC.

■ Sleek and streamlined. XL Wood is perfect for minimalist interiors. Reduced but not reductive, the pared down appearance lets the floor disappear into the background. So your focus remains on the design accents you love. An ideal way to create calm in a busy area.

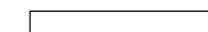

1845 x 244 x 7.5 mm
72.63" x 9.6" x 7.5 mm



4550 Crystal Oak blond grey



4550 Crystal Oak blond grey

■ Pair XL Wood with unusual and exciting interiors. Pampas grass, polished vases and pops of color contrast the calm created by the floor. Or add clean and contemporary XL Wood to a room with older decorative elements like skirting to accent the extraordinary.

XL STONE



4448 Marmor white

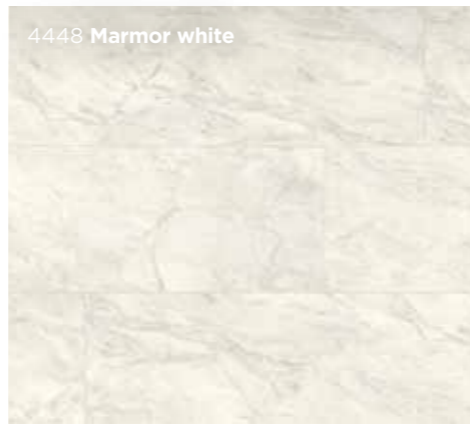

STRIKING BALANCE.

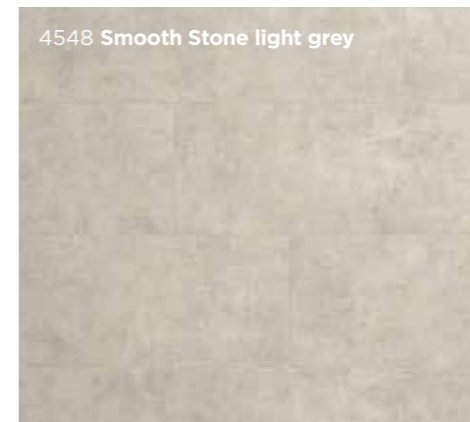

■ A nice, neutral backdrop. XL Stone gets it just right: Not too much, not too little. Harmonious and peaceful, the authentic stone appearance grounds the interior. It strikes the right balance, even in a busy room.

 1380 x 396 x 7.5 mm
 54.33" x 15.59" x 7.5 mm



4448 Marmor white



■ Create an oasis of calm in any room with a pared down decor. XL Stone provides the foundation for a place of focus and concentration, filled only with the bare essentials. Porcelain fixtures and heavy wood accentuate the natural look of the stone.

FACTS

SMART LINE

| SMART LINE | | Wood Classic |
|--|------------------------|---|
| class of usage | EN 16511:2019 | class 33 |
| thickness | EN 16511:2019 | 5.5 mm, 0.21 in. |
| width | EN 16511:2019 | 195 mm, 7.67 in. |
| length | EN 16511:2019 | 1380 mm, 54.33 in. |
| pcs/box | | 10 |
| surface area per box | | 2.69 m ² , 28.96 sqft |
| box/pallet | | 40 |
| weight/box | | 17.38 kg, 38.32 lbs |
| weight/pallet | | 720 kg, 1587 lbs |
| warranty residential (as per separate warranty declaration) https://www.corepel.com/en/service/warranty | | limited lifetime |
| warranty commercial (as per separate warranty declaration) https://www.corepel.com/en/service/warranty | | 5 years |
| surface layer | | Soft Shield |
| unique plank design | | 10 |
| domestic usage interior use | | for example: floor, kitchen, living room, home office, bathroom |
| commercial usage interior use | | for example: classroom, offices, stores |
| waterproof | | 100% waterproof |
| type of installation | | 5G Click |
| surface without transition moldings | | 20 x 20 m, 65 x 65 ft (using state of the art technology) |
| post installation temperature range | | -34°C to +70°C, -30°F to +160°F |
| type of edge | | V-groove 4 sided |
| reaction to fire | CE EN 13501:2010 | B _{fl} -s1, flame retardant, no/low smoke emission |
| floor heating | CE | embedded (liquid based) radiant floor heating |
| thermal resistance | CE | max. 0.1 (m2K)/W |
| antistatic | CE EN 1815:2011 | ≤ 2 kV |
| formaldehyde emission | CE EN 717-1:2005 | Class E1/2020, under detection limit (CARB2/TSCA VI compliant) |
| slip resistance | CE EN 14041:2008 | DS |
| slip resistance | CE DIN 51130:2014 | R10 |
| abrasion resistance (falling-sand method) | EN 16511:2019 | IP ≥ 8000, class 34 |
| micro-scratch resistance | EN 16511:2019 | MSR-A1 |
| impact resistance large ball | EN 16511:2019 | > 1800 mm/ 70.86 in., class 34 |
| resistance to indentation | ISO 24343-1:2012 | ≤ 0.15 mm/ 0.005 in. |
| stain resistance | EN 438-2:2019 | No visible change (acetone, coffee, hydrogen peroxide) |
| strength of joint (short side/long side) | ISO 24334:2019 | 3x higher than Class 34 (11.28 kN/m) |
| gloss level | | 4 points, matt oiled look |
| light fastness | EN 20105:1995 | light fast, ≥ 6 |
| castor chair resistance | EN 425:2002 | 25,000 cycles without any damage |
| burning cigarette | EN 1399:1998 | yes, highly resistant |
| antibacterial resistance | ISO 22196:2011 | antibacterial |
| sustainable certification | | FSC mix |
| VOC emission | ISO 16000 | VOC A+, agBB schema, Floorscore, Greenguard Gold |
| natural wood fiber content | | Core Board more than 50 % |
| PVC free | | yes |
| Phthalates free | | yes |
| heavy metal content | ASTM F963 | pass (>0.25 ppm) |
| attached underlayment | | 1 mm ECO SOUND HYDRO |
| impact sound transmission | ASTM E492 IIC | approx. 68 dB (thanks to ECO SOUND HYDRO underlay) |
| airborne sound transmission | ASTM E90 (STC) | approx. 63 dB (thanks to ECO SOUND HYDRO underlay) |
| effectiveness of floor coverings in reducing impact sound transmission | ASTM E2179 (Delta IIC) | approx. 22 dB (thanks to ECO SOUND HYDRO underlay) |

XL Wood

| XL Wood | | XL Stone |
|---|--|---|
| class 33 | | class 33 |
| 7.5 mm, 0.29 in. | | 7.5 mm, 0.29 in. |
| 244 mm, 9.60 in. | | 396 mm, 15.59 in. |
| 1845 mm, 72.63 in. | | 1380 mm, 54.33 in. |
| 5 | | 5 |
| 2.25 m ² , 24.22 sqft | | 2.75 m ² , 29.60 sqft |
| 45 | | 36 |
| 20.78 kg, 45.81 lbs | | 19.86 kg, 43.39 lbs |
| 960 kg, 2116 lbs | | 740 kg, 1631 lbs |
| limited lifetime | | limited lifetime |
| 5 years | | 5 years |
| Soft Shield | | Soft Shield |
| 24 | | 4 |
| for example: floor, kitchen, living room, home office, bathroom | | for example: floor, kitchen, living room, home office, bathroom |
| for example: classroom, offices, stores | | for example: classroom, offices, stores |
| 100% waterproof | | 100% waterproof |
| 5G Click | | 5G Click |
| 20 x 20 m, 65 x 65 ft (using state of the art technology) | | 20 x 20 m, 65 x 65 ft (using state of the art technology) |
| -34°C to +70°C, -30°F to +160°F | | -34°C to +70°C, -30°F to +160°F |
| V-groove 4 sided | | V-groove 4 sided |
| B _{fl} -s1, flame retardant, no/low smoke emission | | B _{fl} -s1, flame retardant, no/low smoke emission |
| embedded (liquid based) radiant floor heating | | embedded (liquid based) radiant floor heating |
| max. 0.1 (m2K)/W | | max. 0.1 (m2K)/W |
| ≤ 2 kV | | ≤ 2 kV |
| Class E1/2020, under detection limit (CARB2/TSCA VI compliant) | | Class E1/2020, under detection limit (CARB2/TSCA VI compliant) |
| DS | | DS |
| R10 | | R10 |
| IP ≥ 8000, class 34 | | IP ≥ 8000, class 34 |
| MSR-A1 | | MSR-A1 |
| > 1800 mm, 70.86", class 34 | | > 1800 mm, 70.86", class 34 |
| ≤ 0.15 mm/ 0.005 in. | | ≤ 0.15 mm/ 0.005 in. |
| No visible change (acetone, coffee, hydrogen peroxide) | | No visible change (acetone, coffee, hydrogen peroxide) |
| 3x higher than Class 34 (11.28 kN/m) | | 3x higher than Class 34 (11.28 kN/m) |
| 4 points, matt oiled look | | 4 points, matt oiled look |
| light fast, ≥ 6 | | light fast, ≥ 6 |
| 25,000 cycles without any damage | | 25,000 cycles without any damage |
| yes, highly resistant | | yes, highly resistant |
| antibacterial | | antibacterial |
| FSC mix | | FSC mix |
| VOC A+, agBB schema, Floorscore, Greenguard Gold | | VOC A+, agBB schema, Floorscore, Greenguard Gold |
| Core Board more than 50 % | | Core Board more than 50 % |
| yes | | yes |
| yes | | yes |
| pass (>0.25 ppm) | | pass (>0.25 ppm) |
| 1 mm ECO SOUND HYDRO | | 1 mm ECO SOUND HYDRO |
| approx. 68 dB (thanks to ECO SOUND HYDRO underlay) | | approx. 68 dB (thanks to ECO SOUND HYDRO underlay) |
| approx. 63 dB (thanks to ECO SOUND HYDRO underlay) | | approx. 63 dB (thanks to ECO SOUND HYDRO underlay) |
| approx. 22 dB (thanks to ECO SOUND HYDRO underlay) | | approx. 22 dB (thanks to ECO SOUND HYDRO underlay) |

* test certificates available at [corepel.com](https://www.corepel.com)

SKIRTING BOARD

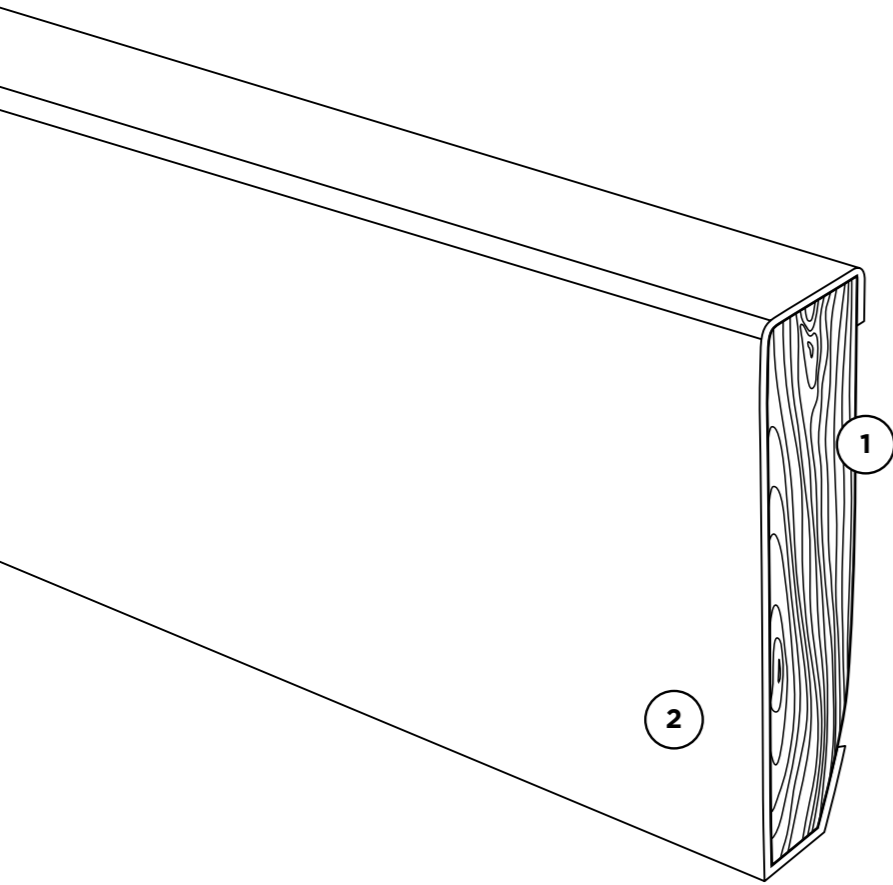

Details:

- | | |
|--|--|
| <ul style="list-style-type: none"> 1. 100% wooden spruce support no swelling as with MDF or other composites 2. Waterproof PP film RAL 9016 with covering also over the bottom edge and partly on the back side to protect against water penetration | <ul style="list-style-type: none"> » Cross section: 16 x 60 mm, 0.63 x 2.36" » Lengths: 2500 or 4000 mm, 98.42 or 157.48" » Available in bundles of 10 » 50 bundles per pallet » Available from stock |
|--|--|



4550 Crystal Oak blond grey

